



XDM6351

INSTALLATION/OWNER'S MANUAL

AM/FM/CD Receiver with Detachable Face

MP3

COMPACT
disc
DIGITAL AUDIO

WMA

USB

S
TM

AUX

Dual[®]



Preparation

Please read entire manual before installation.

Before You Start

- Disconnect negative battery terminal. Consult a qualified technician for instructions.
- Avoid installing the unit where it would be subject to high temperatures, such as from direct sunlight, or where it would be subject to dust, dirt or excessive vibration.

Getting Started

- Remove trim ring from unit.
- Remove 2 transit screws located on top of the unit.
- Insert the supplied keys into the slots as shown, and slide the unit out of the mounting sleeve.
- Install mounting sleeve into opening, bending tabs to secure.
- Connect wiring harness and antenna. Consult a qualified technician if you are unsure.
- Certain vehicles may require an installation kit and/or wiring harness adapter (sold separately).
- Test for correct operation and slide into mounting sleeve to secure.
- Snap trim ring into place.

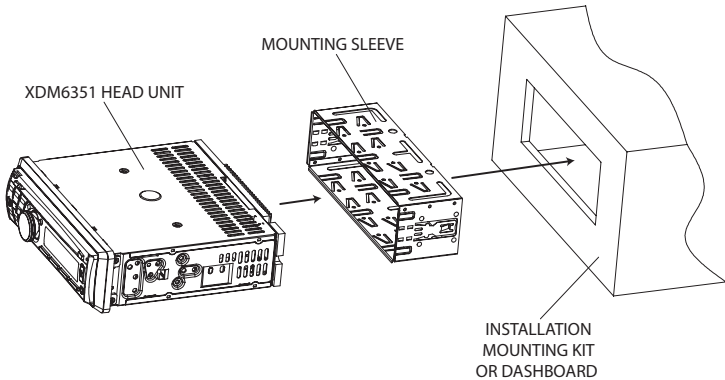
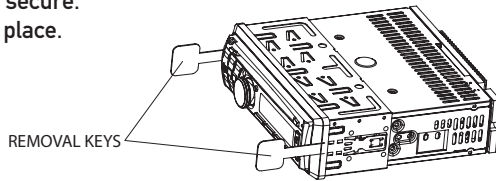

TYPICAL FRONT-LOAD DIN MOUNTING METHOD



Wiring Diagram

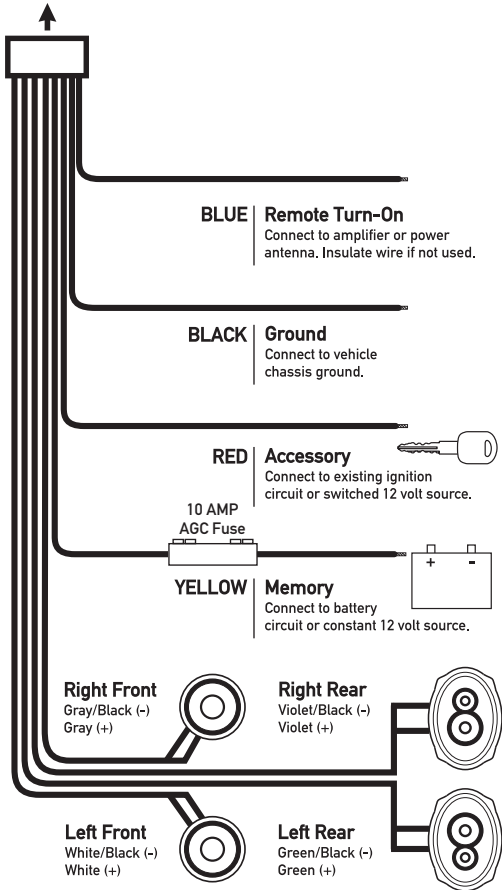
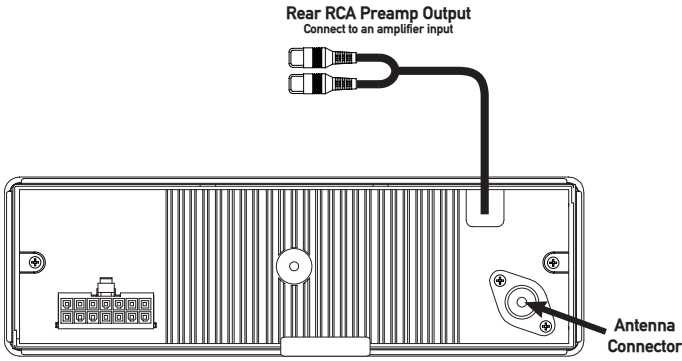

FUSE

When replacing the fuse, make sure new fuse is the correct type and amperage. Using an incorrect fuse could damage the radio.

The XDM6351 uses one 10 amp AGC fuse located in-line.



Control Locations - Receiver

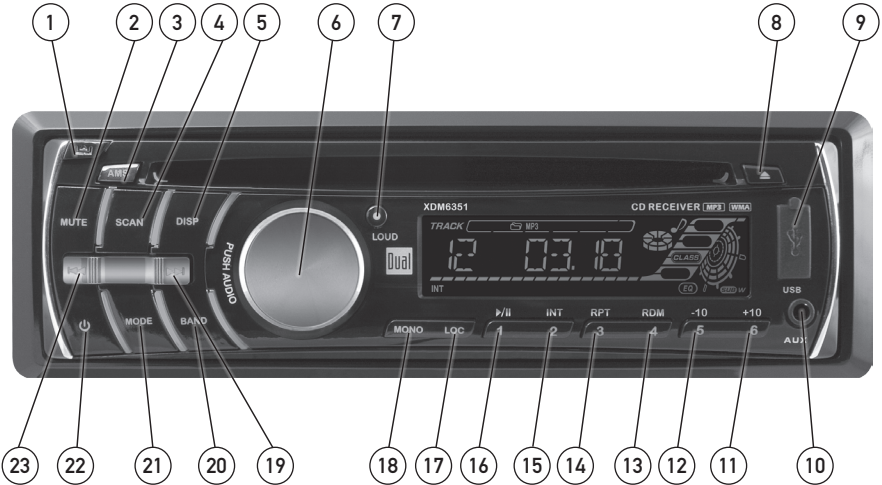

- | | |
|------------------------|----------------------------|
| 1 Release | 13 Preset 4 / Random |
| 2 Mute | 14 Preset 3 / Repeat |
| 3 AMS | 15 Preset 2 / Intro |
| 4 Scan | 16 Preset 1 / Play / Pause |
| 5 Display | 17 Local / Distance |
| 6 Audio / Volume | 18 Mono / Stereo |
| 7 Loudness | 19 Tune / Track Up |
| 8 Eject | 20 Band |
| 9 USB Input | 21 Mode |
| 10 Auxiliary Input | 22 Power |
| 11 Preset 6 / +10 Skip | 23 Tune / Track Down |
| 12 Preset 5 / -10 Skip | |

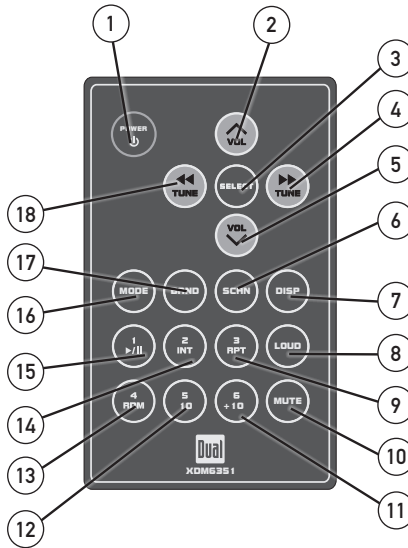

Control Locations - Remote



- | | |
|---------------------|---------------------------|
| ① Power | ⑩ Mute |
| ② Volume Up | ⑪ Preset 6 / +10 |
| ③ Select | ⑫ Preset 5 / -10 |
| ④ Tune / Track Up | ⑬ Preset 4 / Random |
| ⑤ Volume Down | ⑭ Preset 2 / Intro |
| ⑥ Scan | ⑮ Preset 1 / Play / Pause |
| ⑦ Display | ⑯ Mode |
| ⑧ Loudness | ⑰ Band |
| ⑨ Preset 3 / Repeat | ⑱ Tune / Track Down |



General Operation

Faceplate Removal	Press RELEASE and pull away from the left side to remove. To re-install, insert right side of faceplate first then push left side to secure.
Power On/Off	Press  or any other button (except EJECT) to turn the unit on. Press  to turn the unit off.
Mode	Press MODE to select between AM/FM, CD player, auxiliary, USB and SD card. Modes of operation are shown in the display. NOTE: CD and USB modes will not appear unless a CD is inserted or USB device is connected.
Auxiliary Input	The XDM6351 offers a 3.5 mm auxiliary input port on the front panel of the unit for connecting an audio device, MP3 player, etc. Press MODE to select auxiliary input mode.
Volume	Adjust volume using volume knob (00-47).
Display	Press DISP to show the clock. During playback of MP3/WMA files, ID3 tag information, elapsed time, track number and file/folder names will automatically rotate on the display.
Reset	Press RESET upon initial installation or if abnormal operation occurs. Reset button is located behind the front panel.
Set the Clock	With the unit on, press and hold DISP until the clock begins to flash, then release. Turn the volume knob to the right to adjust the hours or to the left to adjust the minutes.
12/24-hour Clock	The clock will display 12-hour AM/PM time in USA frequency spacing mode (PM 10:00). In European frequency spacing mode, the clock will display 24-hour time (22:00).
Setup Menu	Press and hold AUDIO for more than 3 seconds to access the setup menu. Press AUDIO momentarily to select between the menu functions and rotate the volume knob left/right to adjust or activate the desired function.

General Operation - Setup Menu

Menu Function	Options	Action
Equalizer	DSP	Toggles between the following equalization options: OFF, POP, ROCK, CLASS and FLAT).
Beep Confirmation	BEEP OFF	Disables the confirmation beep.
	BEEP ON	Enables the confirmation beep.
Seek Priority	SEEK 1	Enables seek tuning priority.
	SEEK 2	Enables manual tuning priority.
Programmable Turn On Volume	VOL LAST	Programs unit to always turn on at the last volume selected before it was turned off.
	VOL ADJ	Programs unit to always turn on at a specific volume. Any volume level 1-47 can be selected.
Tuner Frequency Spacing	FREQ USA	Programs the unit to USA tuner spacing. (200kHz for FM and 10kHz for AM).
	FREQ EUR	Programs the unit to European tuner spacing. (50kHz for FM and 9kHz for AM).



General Operation

Audio	Press AUDIO momentarily to select between Bass, Treble, Balance and Fader. ↔ BASS → TREBLE → BALANCE → FADER ↔
Bass	Press AUDIO until BAS appears then rotate volume knob left/right to adjust (-7 minimum / +7 maximum).
Treble	Press AUDIO until TRE appears then rotate volume knob left/right to adjust (-7 minimum / +7 maximum).
Balance	Press AUDIO until BAL appears then rotate volume knob left/right to adjust (BAL 10L - BAL 10R). BAL EVEN represents equal balance
Fader	Press AUDIO until FAD appears then rotate volume knob left/right to adjust (FAD 10R - FAD 10F). FAD EVEN represents equal fader



AM/FM Tuner Operation

Seek Tuning	Press TUNE ◀◀ or TUNE ▶▶ momentarily to seek to the next strong station.
Manual Tuning	Press and hold TUNE ◀◀ or TUNE ▶▶ until "MANUAL" appears, then press TUNE ◀◀ or TUNE ▶▶ momentarily to change radio frequency up or down one step at a time. Press and hold to advance quickly. Note: Seek and manual tuning functions are reversed if Seek Priority is set to SEEK 2 in the setup menu (refer to page 7 for details on setting Seek Priority).
Band	Press BAND to select between FM1, FM2, FM3, AM1 and AM2 bands.
Storing and Recalling Station Presets	Up to 18 FM stations and 12 AM stations can be stored. To store a station, select the desired band and station. Press and hold the desired preset button (1-6) for more than 2 seconds. When stored, the preset number will appear in the display. The station can be recalled anytime by pressing the corresponding preset button.
Automatically Store Stations	Press AMS to search for and automatically store six strong stations in the current band.



CD Player Operation

Insert CD	With the label facing up, insert a standard size CD into the CD slot. The CD will automatically begin playback.
Eject CD	Press EJECT to eject the CD. The unit will change to previous mode of operation. If the disc is not removed within 10 seconds, the unit will reload the disc. The unit does not have to be turned on to eject CD.
Track Select	Press TRACK ►► to skip to the beginning of the next track. Press TRACK ◄◄ to return to the beginning of the current track. Pressing TRACK ◄◄ again skips to the beginning of the previous track.
Fast Forward/Reverse	Press and hold TRACK ►► or TRACK ◄◄ on the remote control to fast forward or reverse a track.
Pause	Press ►/ to temporarily stop CD playback. Press ►/ again to resume playback.
Intro	Press INT to play the first 10 seconds of each track. Press INT again to turn the Intro function off.
Repeat	Press RPT to continuously repeats selected track. Press RPT again to turn the Repeat function off.
Random	Press RDM to play all tracks in random order. Press RDM again to turn the Random function off.
CD-R/CD-RW Compatibility	<p>Some CD-Rs and CD-RWs may be incompatible with this unit, depending on media type and recording method. In addition, the following CDs may be incompatible with this unit:</p> <p>CDs exposed to extreme temperatures or direct sunlight for extended periods of time. CDs recorded in which a recording session failed or a re-recording was attempted and, or encrypted or copy-protected CDs which do not conform to the audio CD-DA red book recording standard.</p>



CD Player Operation - MP3/WMA Files

Playing an MP3/WMA CD	When an MP3/WMA encoded disc is first inserted, "LOAD" will appear in the display. Depending on the number of files and folders, this may take several seconds.
Displaying Information	ID3 tag and file/folder information will be automatically changed during playback. Press DISP to view the clock. Default display will resume after five seconds.
Character Support	<p>Maximum character display information</p> <ul style="list-style-type: none"> • Track name – 64 character maximum • Directory name – 64 character maximum • *Song title – 64 character maximum • *Artist name – 64 character maximum • *Album name – 64 character maximum <p>*Song title, artist name and album name will only be displayed if included with the MP3/WMA file.</p> <p>When referring to MP3/WMA playback, the following terms are synonymous:</p> <ul style="list-style-type: none"> • File name and track name • Folder name and directory name
Track Jump	Press +10 to skip ahead 10 tracks. Press -10 to skip back 10 tracks.
Intro	Press INT to play the first 10 seconds of each track. Press INT again to turn the Intro function off.
Repeat	Press RPT to continuously repeats selected track. Press RPT again to turn the Repeat function off.
Random	Press RDM to play all tracks in random order. Press RDM again to turn the Random function off.



CD Player Operation - MP3/WMA Files

Media Compatibility

The following types of discs/files are compatible:

- CD-ROM (ISO), CD-R, CD-RW
- CD-DA
- MP3 data
- WMA data

The following types of discs/files are not compatible:

- WMA files that are protected by DRM (Digital Rights Management).
- WMA lossless format
- Discs recorded with Track At Once or packet writing
- MP3 PRO format
- MP3 playlists
- WAV format

Playback Order

MP3/WMA playback sequence is based on recorded order of files and begins in the root folder of the disc. Any empty folders or folders that do not include MP3/WMA files are skipped. This unit may not play files in the order they were recorded in. Refer to your recording software's user's manual for more information.

Compatible Recording Formats

- ISO9660 level 1
- ISO9660 level 2
- Yellow Book MODE 1
- Yellow Book MODE 2 FORM 1
- Multi session
- Maximum folders and files - 256
- Maximum folder levels - 8
- MPEG-1/2/2.5 Audio Layer-3

ISO9660 standards:

- Maximum nested folder depth is 8 (including the root folder).
- Valid characters for folder/file names are letters A-Z (all caps), numbers 0-9, and “_” (underscore). Some characters may not be displayed correctly, depending on the character type.
- This device can play back discs in Joliet, Romeo, and other standards that conform to ISO9660. MP3/WMA written in the formats other than the above may not play and/or their file names or folder names may not be displayed properly.

CD Player Operation - MP3/WMA Files

Additional MP3/WMA Information

When playing a disc recorded with regular audio files (CD-DA or .WAV) and MP3/WMA files, the unit will play the MP3/WMA files only.

Only MP3 files with filename extension (.mp3) can be played.
Only WMA files with filename extension (.wma) can be played.

Do not attempt to play discs which contain non-MP3/WMA files with the MP3/WMA extension.

Sampling Frequency Rates

MP3

8kHz ~ 48kHz

WMA

8kHz ~ 48kHz

Transfer Bit rates

MP3

8kbps ~ 320kbps constant
Variable bit rates

WMA

8kbps ~ 384kbps constant
Variable bit rates

Note: Some files may not play or be displayed correctly, depending on sampling rates and bit rates.

MP3 Tag Display

ID3 tags Version 1.0 to 2.0.
This model will not display ID3 Version 2.0 or greater tags.

Recommended Settings

For best results, use the following settings when burning an MP3 disc:

128kbps or higher constant bit rate
44.1kHz or higher sampling frequency

For best results, use the following settings when burning a WMA disc:

64kbps or higher constant bit rate
32kHz or higher sampling frequency



SD Card / USB Operation

Connecting a USB Device (sold separately)	To play MP3/WMA files from most USB mass storage devices, line up the USB connector and insert the USB device into the XDM6351's USB port.
Inserting an SD Card (sold separately)	To play MP3/WMA files from an SD card, insert the card horizontally with the label facing up into the SD card slot located behind the front panel.
Playing Music	When a USB device is first connected, "LOAD" will appear in the display and playback will begin momentarily. To begin playing music from an SD card, press MODE to select SD mode and begin playback. Depending on the number of files and folders, it may take several seconds for the device to begin playing. If no valid MP3/WMA files are detected, "NO FILE" will be displayed and the last mode will be resumed.
Track Select	Press TRACK ►► to skip to the beginning of the next track. Press TRACK ◀◀ to return to the beginning of the current track. Pressing TRACK ◀◀ again skips to the beginning of the previous track.
Fast Forward and Reverse	Press and hold TRACK ►► or TRACK ◀◀ on the remote control to fast forward or reverse a track.
Pause	Press ►/ to temporarily stop USB playback. Press ►/ again to resume playback.
Displaying Information	ID3 tag and file/folder information will be automatically changed during playback. Press DISP to view the clock. Default display will resume after five seconds.
Track Jump	Press +10 to skip ahead 10 tracks. Press -10 to skip back 10 tracks.
Intro	Press INT to play the first 10 seconds of each track. Press INT again to turn the Intro function off.
Repeat	Press RPT to continuously repeats selected track. Press RPT again to turn the Repeat function off.
Random	Press RDM to play all tracks in random order. Press RDM again to turn the Random function off.

SD Card / USB Operation

Character Support

- Maximum character display information
- Track name – 64 character maximum
 - Directory name – 64 character maximum
 - *Song title – 64 character maximum
 - *Artist name – 64 character maximum
 - *Album name – 64 character maximum

*Song title, artist name and album name will only be displayed if included with the MP3/WMA file.

Media Compatibility

The following types of files are compatible:

- MP3 data
- WMA data

The following types of files are not compatible:

- WMA files that are protected by DRM (Digital Rights Management).
- WMA lossless format
- MP3 PRO format
- MP3 playlists
- WAV format

Playback Order

MP3/WMA playback sequence is based on order the files are copied to the USB/SD device and begins in the root folder. Any empty folders or folders that do not include MP3/WMA files are skipped. Depending on your software, the playback order may vary.

Playback Capacity

- Maximum number of files: 2000
- Maximum number of folders: 500 plus the root directory
- Maximum number of files in each folder and root: 2000
- Maximum number of folder levels (sub folders): 8 (7 levels plus the root)

Note: If the number of files/folders exceeds the maximum outlined above, the additional files/folders will be ignored.

Note: Devices that exceed the maximum number of files or folders may not function properly.

USB Device Compatibility

Due to the differences of USB devices and SD cards, some devices may not be compatible. USB devices and SD cards must be 'mass storage class' and formatted to the FAT or FAT32 file system in order to ensure compatibility.

USB/SD Device Capacity

USB/SD cards must be 32GB or smaller in capacity to be compatible.



SD Card / USB Operation

**Additional MP3/WMA
Information**

Only MP3 files with filename extension (.mp3) can be played. Only WMA files with filename extension (.wma) can be played. Do not attempt to play non-MP3/WMA files with the MP3/WMA extension.

**Sampling Frequency
Rates**

MP3

8kHz ~ 48kHz

WMA

8kHz ~ 48kHz

Transfer Bit rates

MP3

8kbps ~ 320kbps constant
Variable bit rates

WMA

8kbps ~ 384kbps constant
Variable bit rates

Note: Some files may not play or be displayed correctly, depending on sampling rates and bit rates.

MP3 Tag Display

ID3 tags Version 1.0 to 2.0

Note: If an invalid ID3 tag version is detected, "NO SUPPORT" will scroll on the display.



Music Search - MP3/WMA Files

Time Search Press **AMS** until "TIME SCH" appears. Turn the **volume knob** left/right to choose the desired elapsed time in the current song. Press **AUDIO** to begin playback from the displayed elapsed time.

Track Search Press **AMS** until "TRK SCH" appears. Turn the **volume knob** to choose the first digit in the track number. After one second, the first digit is saved. Turn the **volume knob** to choose the second digit, repeating the process until the desired track number is shown. Press **AUDIO** to begin playback for the displayed track.

Example: To choose track 100, press **AMS** until "TRK SCH" appears, then turn the **volume knob** until "1" appears. Wait one second, then choose "0". Wait one second, then choose "0". Press **AUDIO** to begin playing track number 100.

File Search Press **AMS** until "FILE SCH" appears. Turn the **volume knob** to cycle through all the songs on the device. The songs will be listed in the order that they are copied to the device. Press **AUDIO** to begin playback when the desired song is displayed.

Character Search Press **AMS** until "CHAR SCH" appears. Turn the **volume knob** to choose the first character in the artist name. Once the first character is chosen, wait one second, then press **AUDIO** to search for all artists that begin with that letter. A list of songs by artists with names beginning with the chosen letter will be available. Turn the **volume knob** to cycle through these songs, and press **AUDIO** to begin playback.

Example: Choose "B" then press **AUDIO** to display all the songs from artists that have names beginning with B.



Limited One Year Warranty

This warranty gives you specific legal rights. You may also have other rights which vary from state to state.

Dual Electronics Corp. warrants this product to the original purchaser to be free from defects in material and workmanship for a period of one year from the date of the original purchase.

Dual Electronics Corp. agrees, at our option, during the warranty period, to repair any defect in material or workmanship or to furnish an equal new, renewed or comparable product (whichever is deemed necessary) in exchange without charges, subject to verification of the defect or malfunction and proof of the date of purchase. Subsequent replacement products are warranted for the balance of the original warranty period.

Who is covered? This warranty is extended to the original retail purchaser for products purchased from an authorized Dual dealer and used in the U.S.A.

What is covered? This warranty covers all defects in material and workmanship in this product. The following are not covered: software, installation/removal costs, damage resulting from accident, misuse, abuse, neglect, product modification, improper installation, incorrect line voltage, unauthorized repair or failure to follow instructions supplied with the product, or damage occurring during return shipment of the product. Specific license conditions and copyright notices for the software can be found via www.dualav.com.

What to do?

1. Before you call for service, check the troubleshooting guide in your owner's manual. A slight adjustment of any custom controls may save you a service call.
2. If you require service during the warranty period, you must carefully pack the product (preferably in the original package) and ship it by prepaid transportation with a copy of the original receipt from the retailer to an authorized service center.
3. Please describe your problem in writing and include your name, a return UPS shipping address (P.O. Box not acceptable), and a daytime phone number with your shipment.
4. For more information and for the location of the nearest authorized service center please contact us by one of the following methods:

- Call us toll-free at 1-866-382-5476
- E-mail us at cs@dualav.com

Exclusion of Certain Damages: This warranty is exclusive and in lieu of any and all other warranties, expressed or implied, including without limitation the implied warranties of merchantability and fitness for a particular purpose and any obligation, liability, right, claim or remedy in contract or tort, whether or not arising from the company's negligence, actual or imputed. No person or representative is authorized to assume for the company any other liability in connection with the sale of this product. In no event shall the company be liable for indirect, incidental or consequential damages.

Troubleshooting

Problem	Cause	Action
Unit will not turn on (no power)	Yellow wire not connected or incorrect voltage Red wire not connected or incorrect voltage	Check connections for proper voltage (11~16VDC)
	Black wire not connected	Check connection to ground
	Fuse blown	Replace fuse
Unit has power (but no sound)	Speaker wires not connected	Check connections at speakers
	One or more speaker wires touching each other or touching chassis ground	Insulate all bare speaker wires from each other and chassis ground
Unit blows fuses	Yellow or red wire touching chassis ground	Check for pinched wire
	Speaker wires touching chassis ground	Check for pinched wire
	Incorrect fuse rating	Use fuse with correct rating
Excessive skipping	Unit is not mounted correctly or backstrap is not secure	Check mounting sleeve and backstrap support
	Physical defect in media (CD, CD-R or CD-RW)	Check media for scratches
ERR FILE appears on display	Disc read error	Press eject or RESET
	Focus error or disc is in upside down	Press eject or RESET
	The WMA file is copy-protected by DRM (Digital Rights Management)	Write disc using WMA files that are not copy-protected
NO FILE appears on display	No playable MP3/WMA files found on the device	Check the device for valid MP3/WMA files
Unit will not accept a disc	CD mechanism position out of alignment	Press EJECT to reset CD mechanism position
	CD transit screws still in place	Remove 2 transit screws located on top of the unit
NO SUPPORT appears on display	An invalid ID3 tag version is present	Version 1.0 to 2.0 ID3 tags are supported.



Specifications

CD Player	Frequency response: 20Hz-20kHz Channel separation @ 1kHz: >60dB D/A converter: 1 Bit
FM Tuner	Tuning range: 87.5MHz-107.9MHz Usable sensitivity: 8.5dBf 50dB quieting sensitivity: 10dBf Stereo separation @ 1kHz: >30dB Frequency response: 30Hz-13kHz
AM Tuner	Tuning range: 530kHz-1710kHz Usable sensitivity: <42dBu Frequency response: 30Hz-2.2kHz
General	Speaker output impedance: 4~8 ohms Line output voltage: 2 Volts RMS Dimensions: 7" x 7" x 2" (178 x 178 x 50 mm)

Design and specifications subject to change without notice.



CEA-2006 Power Standard Specifications (reference: 14.4VDC +/- 0.2V, 20Hz~20kHz)

Power Output: 18 Watts RMS x 4 channels at 4 ohms and \leq 1% THD+N
Signal to Noise Ratio: 70dBA (reference: 1 watt into 4 ohms)



FCC Compliance

This device complies with Part 15 of the FCC Rules. Operation is subject to the following two conditions:

- (1) this device may not cause harmful interference, and
- (2) this device must accept any interference received, including interference that may cause undesired operation.

Warning: Changes or modifications to this unit not expressly approved by the party responsible for compliance could void the user's authority to operate the equipment.

Note: This equipment has been tested and found to comply with the limits for a Class B digital device, pursuant to Part 15 of the FCC Rules. These limits are designed to provide reasonable protection against harmful interference in a residential installation. This equipment generates, uses and can radiate radio frequency energy and, if not installed and used in accordance with the instructions, may cause harmful interference to radio communications. However, there is no guarantee that interference will not occur in a particular installation. If this equipment does cause harmful interference to radio or television reception, which can be determined by turning the equipment off and on, the user is encouraged to try to correct the interference by one or more of the following measures:

- Reorient or relocate the receiving antenna.
- Increase the separation between the equipment and receiver.
- Connect the equipment into an outlet on a circuit different from that to which the receiver is connected.
- Consult the dealer or an experienced radio/TV technician for help.



Notes





Dual Electronics Corp.
Toll Free: 1-866-382-5476

www.dualav.com
©2011 Dual Electronics Corp. All rights reserved.

The SD logo is a trademark of the SD Card Association.

Other trademarks and trade names are those of their respective owners.

NSA0611-V02